

- Accuracy:  $\pm 0.5\%$  F.S.
- Measuring range: 20, 30, 50, 100, 150, 250, 300, 600 Adc...
- Output signal: 50 mVdc or 60 mVdc
- Standard and custom options available for OEM design

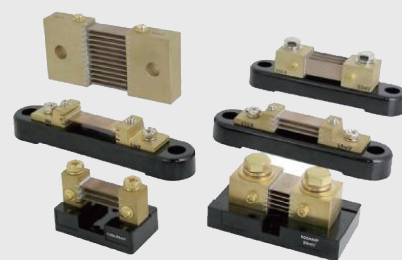

**ORDER INFORMATION**

BST - [Code 1] / [Code 2]

Code 1	Input Range	Code 2	Output
20	0~20 Adc	50	50 mVdc
30	0~30 Adc	60	60 mVdc
50	0~50 Adc		
100	0~100 Adc		
150	0~150 Adc		
250	0~250 Adc		
300	0~300 Adc		
O	Option		

**DIMENSION (mm)**

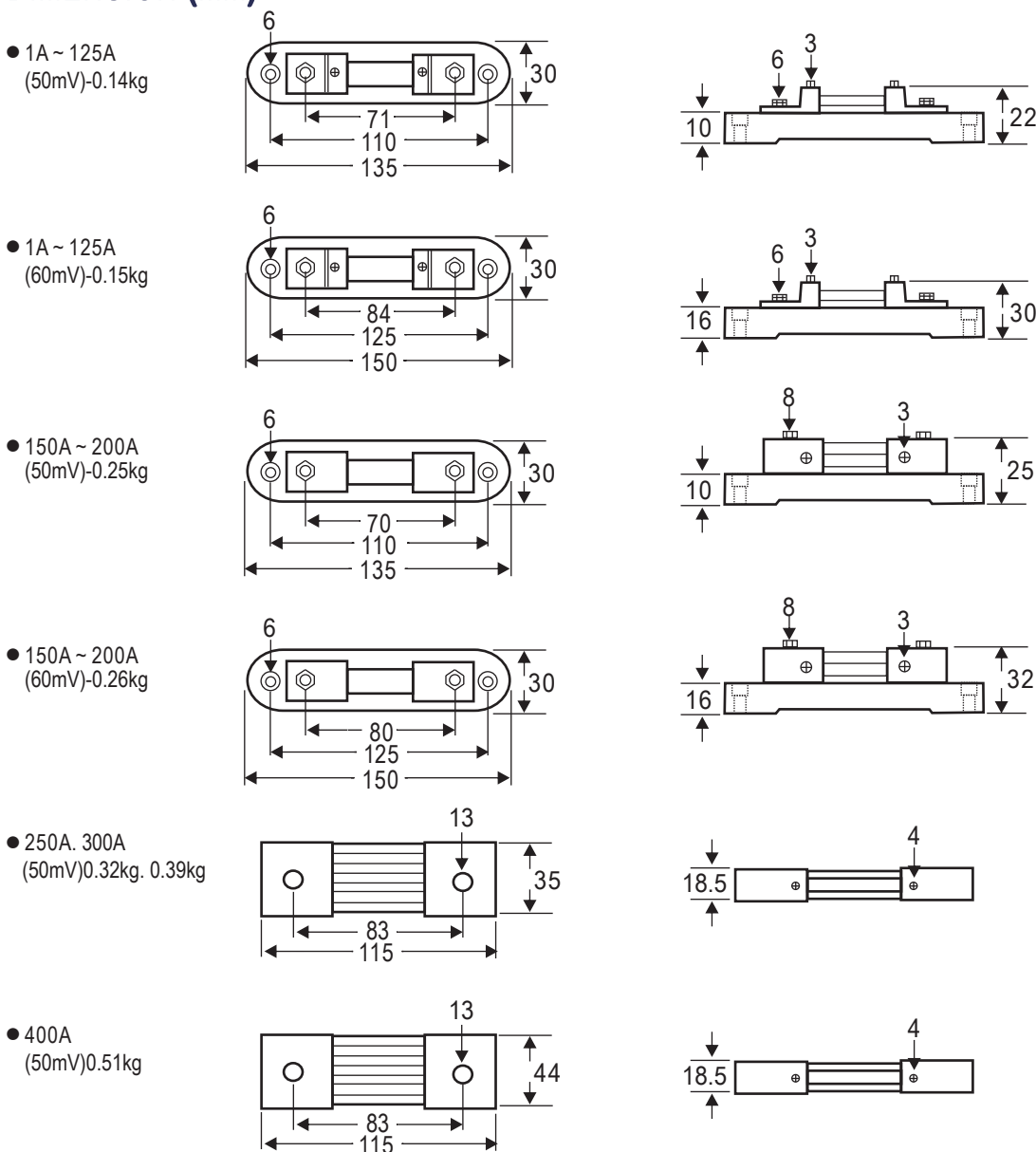

● 500A  
(50mV)0.64kg

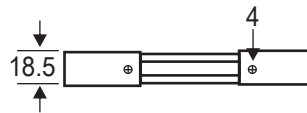
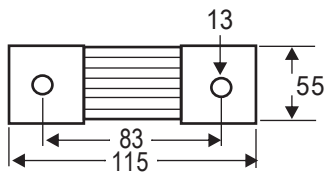

● 600A  
(50mV)0.8kg

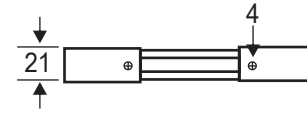
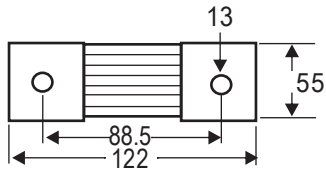

● 250A. 300A  
(60mV)0.33kg. 0.40kg

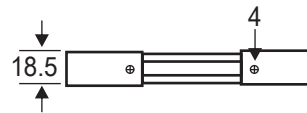
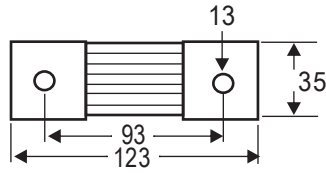

● 400A  
(60mV)0.52kg

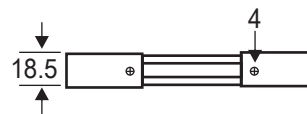
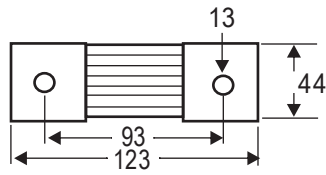

● 500A  
(60mV)0.65kg

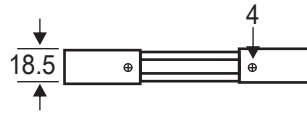
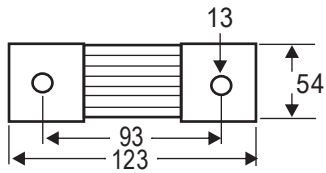

● 600A  
(60mV)0.81kg

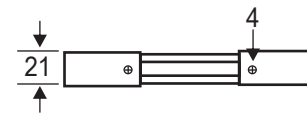
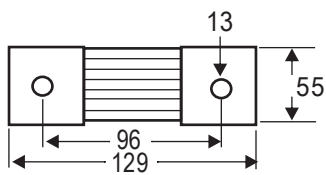

● 700A  
(50mV)0.9kg

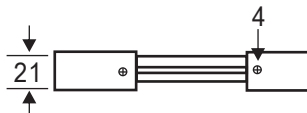
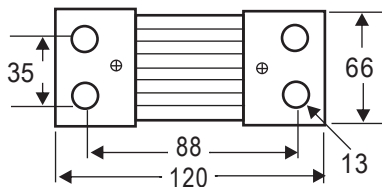

● 800A  
(50mV)0.99kg

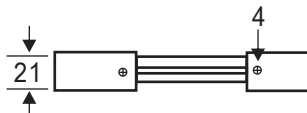
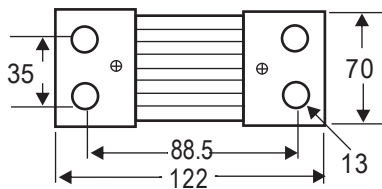

● 1000A  
(50mV)1.45kg

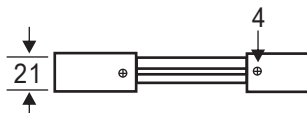
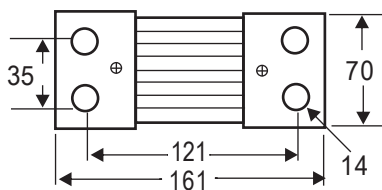

● 1200A  
(50mV)1.8kg

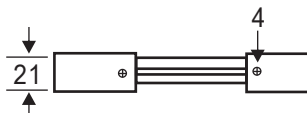
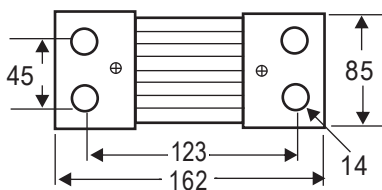

● 1500A  
(50mV)2.17kg

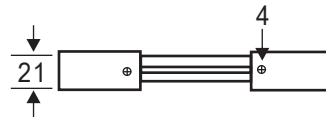
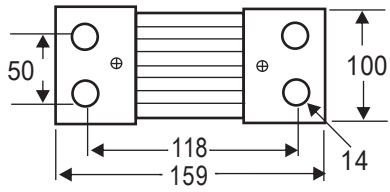

● 800A  
(60mV)1kg

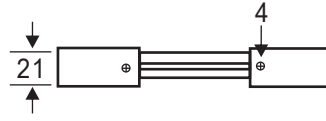
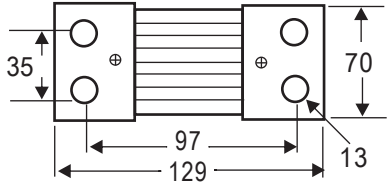

● 1000A  
(60mV)1.5kg

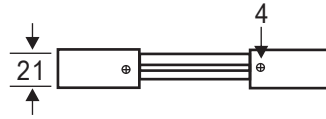
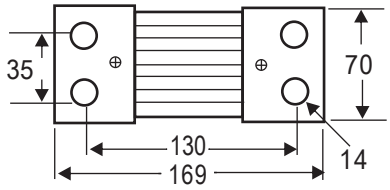

● 1200A  
(60mV)1.82kg

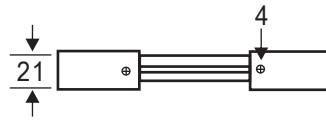
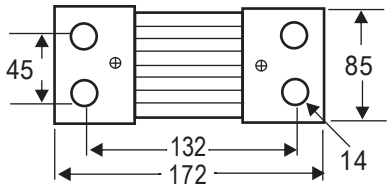

● 1500A  
(60mV)2.2kg

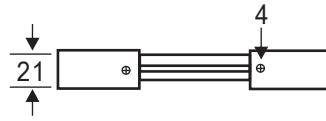
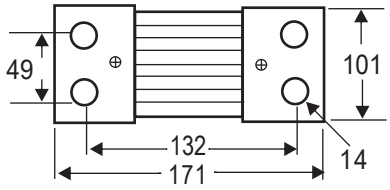

● 2000A  
(50mV)4.6kg

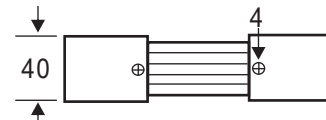
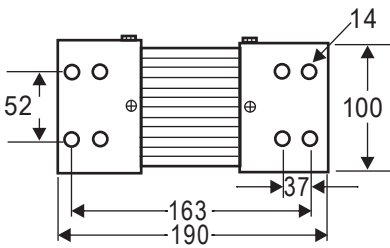

● 2500A  
(50mV)5.2kg

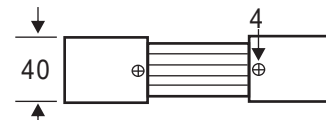
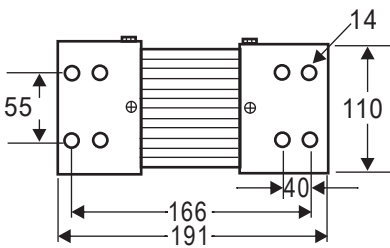

● 3000A  
(50mV)6.9kg

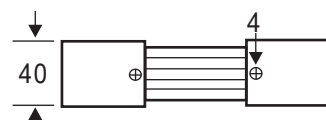
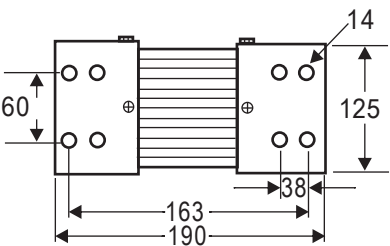

● 3500A  
(50mV)8.2kg

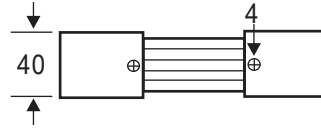
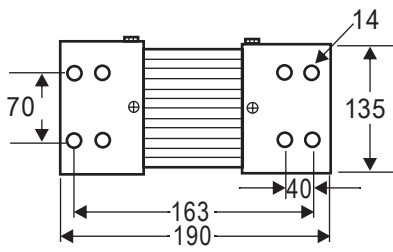

● 4000A  
(50mV)9.7kg

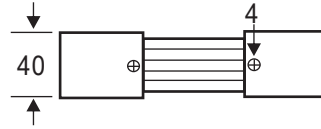
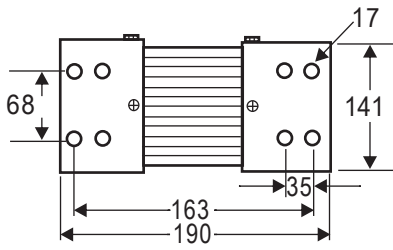

● 2000A  
(60mV)4.7kg

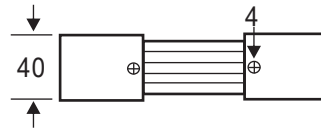
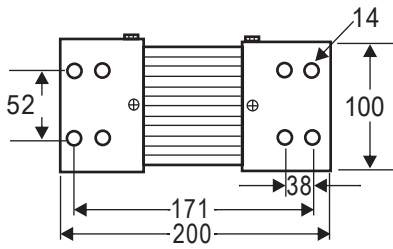

● 2500A  
(60mV)5.3kg

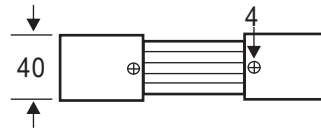
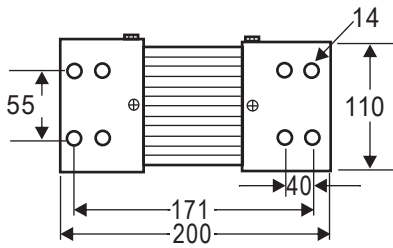

● 3000A  
(60mV)7.1kg

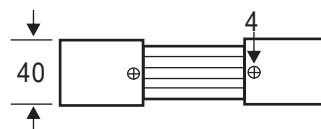
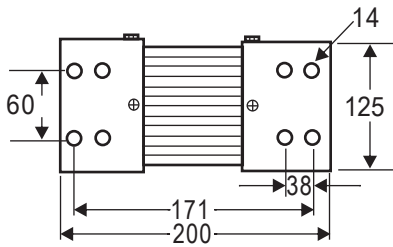

● 3500A  
(60mV)8.2kg

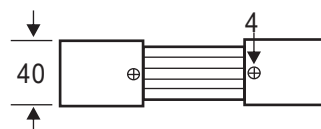
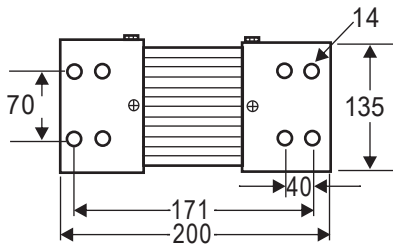

● 4000A  
(60mV)9.9kg

